

Fiber Coupled 915 nm Multimode Laser Module

2pin Package Module

940, 975nm Available

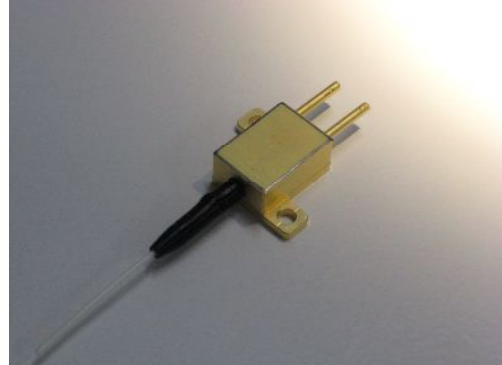

Product Specifications at 25°C

Type	OE915G4		
Model No.	915041412M6		
Fiber light output	Pf	W	10
Center wavelength	λ_c	nm	915
Threshold current	I _{th}	A	1.2
Operating current	I _{op}	A	13.0
Operating voltage	V _{op}	V	1.7
Spectral width	$\Delta\lambda$	nm	2
Spectral temperature shift	$d\lambda/dT$	nm/K	0.3
Fiber specification	L _{fiber}	m	1.0
Fiber Core diameter	ϕ_{core}	um	105
Fiber Clad diameter	ϕ_{clad}	um	125
Fiber N.A.	-	-	0.22

Absolute Maximum Ratings

			min	max	
Forward current	I _{max}	A	-	15.0	OE915G4
Reverse voltage	V _{rmax}	V	-	2.0	
Operating temperature	T _{op}	°C	-20	50	
Storage temperature	T _{st}	°C	-40	85	
Process temperature	T _{pr}	°C	-	250	5s, package lead

OPTOENERGY

Typical Characteristics

915041412M6

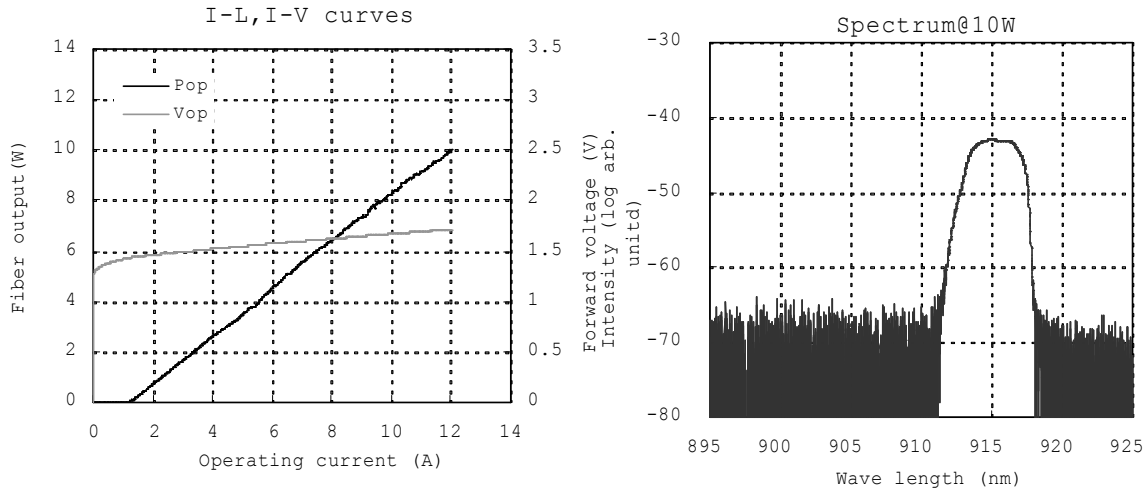

Package

2pin Package Module

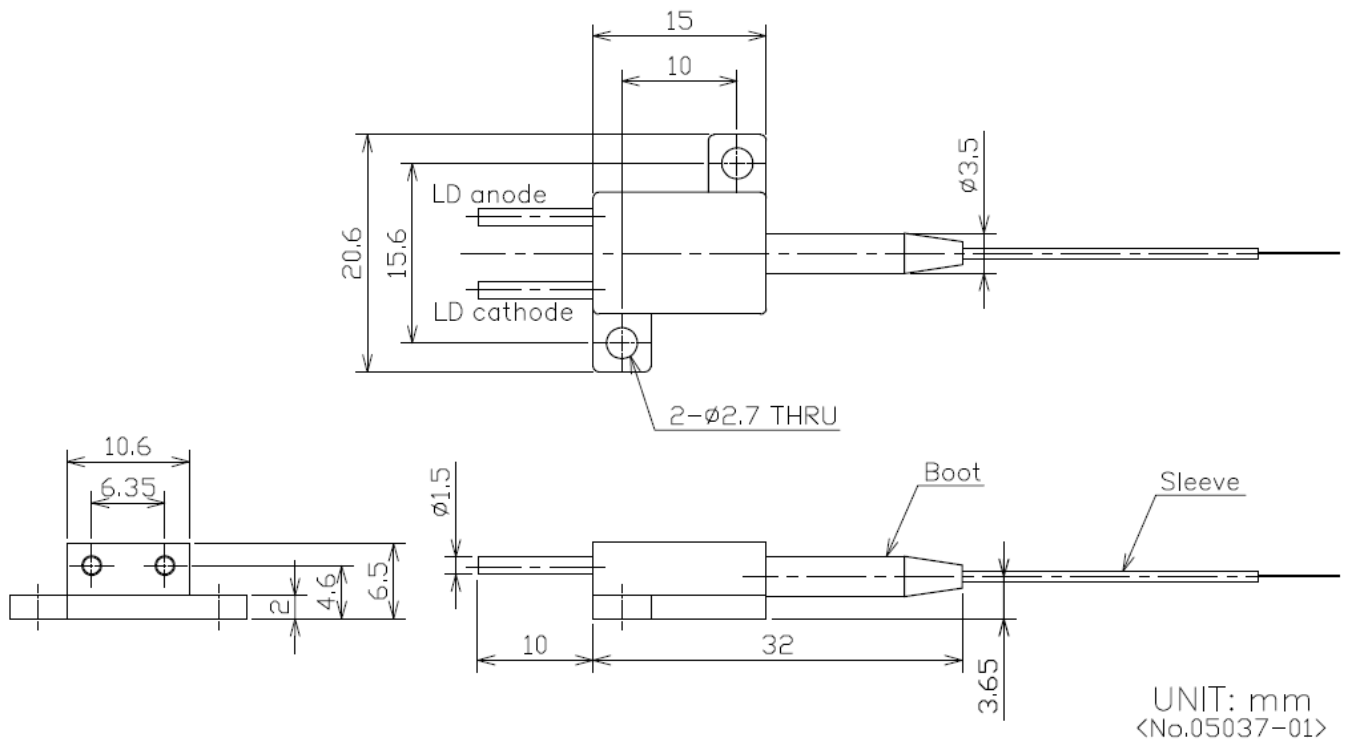

Caution

This laser emits invisible radiation which may be harmful to the eyes. Avoid direct or reflected light from this device. Because of the small size of these devices, each of the labels is attached to the individual shipping container.

